

Estrella Simplicity

INSTALLATION INSTRUCTIONS



PLEASE READ THESE INSTRUCTIONS CAREFULLY BEFORE INSTALLATION AND LEAVE A COPY WITH THE END USER FOR FUTURE REFERENCE.

SAFETY INFORMATION – We recommend that luminaires be installed by a fully qualified and competent electrician who understands building regulations and the current IEE wiring regulations. The light source contained in this luminaire shall only be replaced by the manufacturer or a qualified professional.

Before commencing any installation or maintenance work, ensure that the electricity is switched off at the mains.



IMPORTANT USER INFORMATION

Please install and use strictly in accordance with these instructions. Make sure that you have all the tools and equipment to complete the installation safely and correctly. Improper installation could cause harm to your property and/or person and void your warranty.

It is the installer's responsibility to consider fire & safety risk and take appropriate precautions.

This product is a CLASS 2.

PRE INSTALLATION INSTRUCTIONS & GUIDELINES

- Switch off the mains before commencing installation and remove the appropriate circuit fuse or lock off the Mains Circuit Board.
- Do not introduce any parts other than the ones provided to the inside of this fitting, as this can be dangerous and it would void your warranty.
- The luminaire must be installed on to a ceiling which should be firm enough to hold the weight of more than five times of the fitting itself.
- The luminaire must not be installed above hot objects such as ovens to avoid damage to the fitting.
- LED Chips can be susceptible to damage by gases, vapours, etc emitted by other materials, especially rubber, causing a severe reduction in light output.
- Ensure there is adequate space for ventilation around the fitting.
- Ensure that all electrical connections are tight with no loose strands.
- This product is designed for permanent connection to fixed wiring and must be fixed to a suitable circuit (protected with the appropriate Mains Circuit Board or fuse).
- This product is not suitable for use on highly flammable surfaces (e.g. polystyrene, textiles).
- Before making the fixing hole(s), check that there are no obstructions hidden beneath the mounting surface, such as pipes or cables.

SPECIFICATION

Wattage: 20W (R311101/WT/4K) | 28W (R311102/WT/4K) | 35W (R311103/WT/4K) | 20W (R311101/BK/4K) | 28W (R311102/BK/4K) | 35W (R311103/BK/4K) | 10W (R311104/WT/4K) | 14W (R311105/WT/4K) | 18W (R311106/WT/4K) | 10W (R311104/BK/4K) | 14W (R311105/BK/4K) | 18W (R311106/BK/4K)

Power Supply: 220-240V, 50/60Hz

Power Factor: >0.90

CCT: 4000K

CRI: >80Ra

Estrella Simplicity

DIMENSIONS

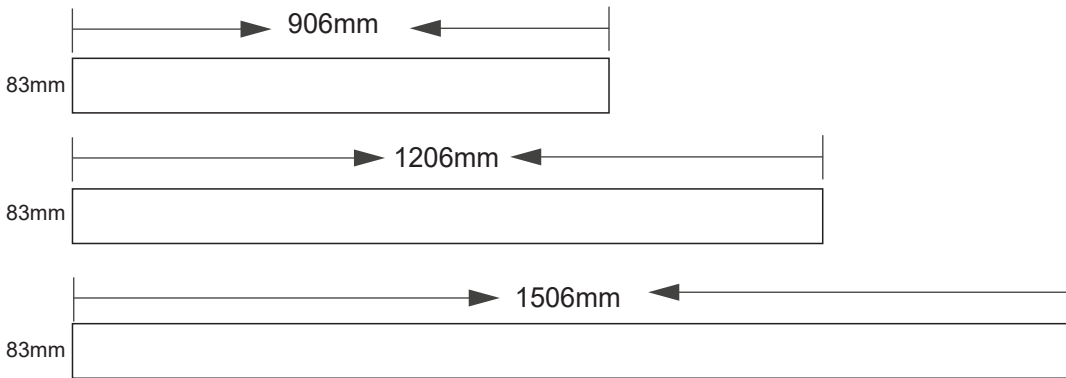
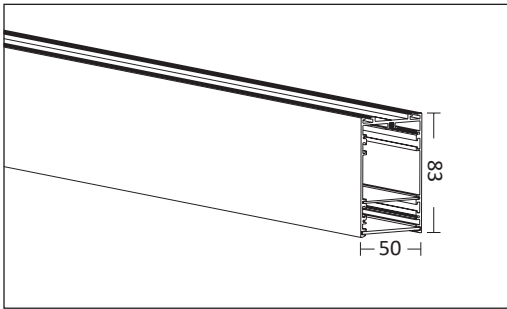

SHAPE PIECES

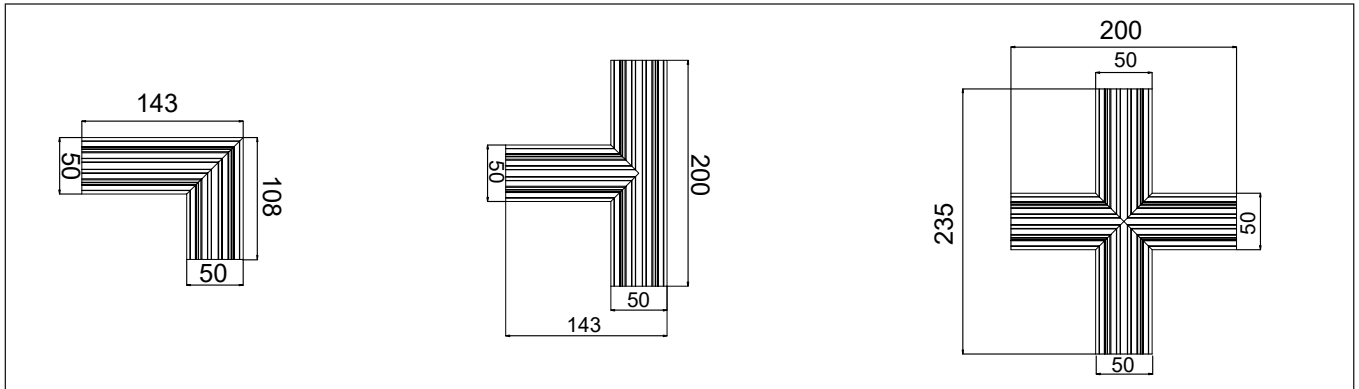

ENVIRONMENTAL PROTECTION

Waste Electrical & Electronic Equipment Regulations (WEEE) requires that any of our products showing this marking must not be disposed of with other household or commercial waste. To prevent possible harm to the environment or human health from uncontrolled waste disposal, please separate any such product from other waste types and recycle it responsibly at your local facilities. Check with your Local Authority, Recycling Centre or retailer for recycling advice.

WARRANTY

This product is in warranty in the UK for a period of 5 year from the date of purchase. The guarantee is invalid in the case of improper use, installation, tampering, removal of the Q.C. date label, installation in an improper working environment or installation not according to the current edition of the IEE Wiring Regulations. Should this product fail during the warranty period, it will be replaced free of charge, subject to the aforementioned conditions and return of the faulty unit. We do not accept responsibility for any installation costs associated with the replacement of this product. Your statutory rights are not affected.

Estrella Simplicity

SUSPENSION MOUNTING GUIDE

Before following these steps please ensure you have read and adhered to the guidelines and information overleaf. Remove the product from the box and inspect it for any damage. If the luminaire is in a good condition, proceed with the installation.

SUSPENSION POINTS

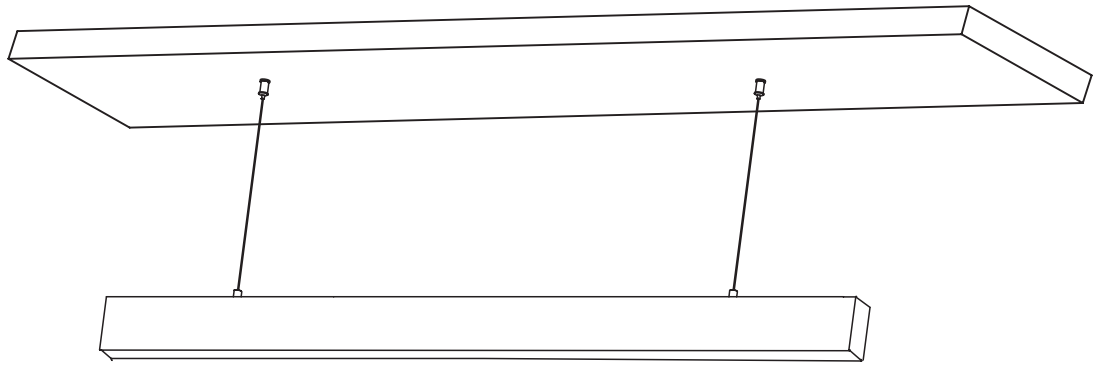

Linear Piece

We recommend 2 suspension points per linear piece
Mounting points are recommended at 200mm from either end of a linear piece.

PARTS CHECKLIST



**Ceiling Suspension
Fixture X2**



**Ceiling Suspension
Cap X2**



**Suspension Cable
X2**



**Fitting Suspension
Cap X2**



**Fitting Suspension
Fixture X2**



**Mounting Clip
X2**



M3*30 Screws X2



Raw Plugs X2





**M4* Nut
X2**



**M4*8 Bolts
X2**

Estrella Simplicity

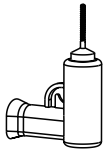
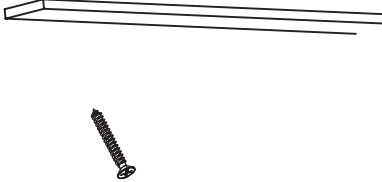
SUSPENSION MOUNTING STEPS

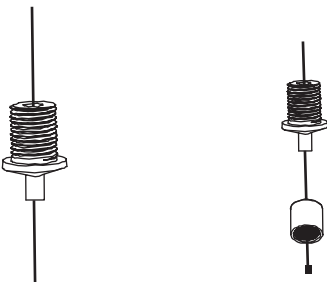
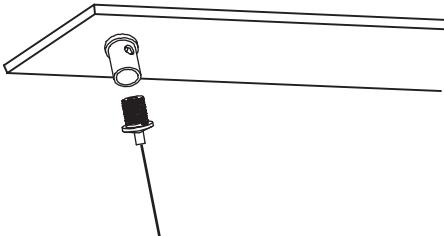
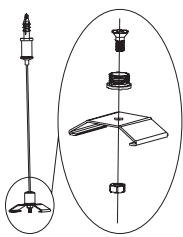
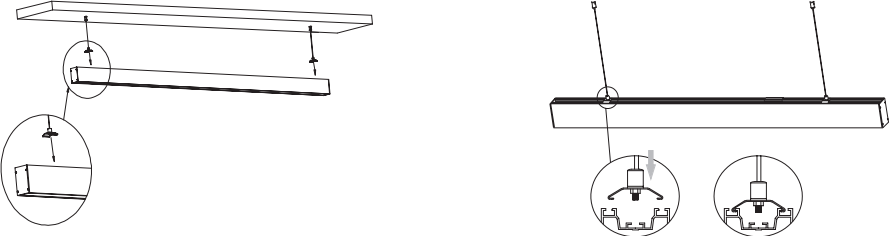
<p>STEP 1</p> <p>Ensure power is turned off. Drill two 6mm holes into the ceiling for the suspension points. Insert the supplied raw plugs into the holes.</p> 	<p>STEP 2</p> <p>Insert M3 screw into Ceiling Fixing Point and screw into the raw plug that sits in the ceiling.</p> 
<p>STEP 3</p> <p>Slide the Suspension Cable through the threaded end of the Fitting Suspension Fixture.</p> 	<p>STEP 4</p> <p>Slide the Suspension Cable through the smaller end of the Ceiling Suspension Cap.</p> 
<p>STEP 5</p> <p>Screw the Ceiling Suspension Cap into the Ceiling Suspension Point.</p> 	<p>STEP 6</p> <p>Secure the Fitting Suspension Cap to the Mounting Clip with the M4 Nut provided. Then attach to the Suspension Cable via the Fitting Suspension Fixture.</p> 
<p>STEP 5</p> <p>Clip the Mounting Clips onto the fitting. Adjust the suspension cable to the desired lengths.</p> 	

Estrella Simplicity

CONNECTING SHAPE PIECES

PARTS CHECKLIST



**Side Connector
Plate X2**



**Back Connector
Plate X1**

STEP 1

Remove the end cap of the linear piece (on the opposite side from the exiting cable). Then Remove the end cap of the connecting shape piece.

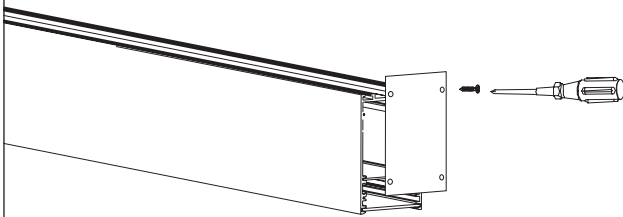

STEP 2

Connect the cables from each piece using the attached connector.

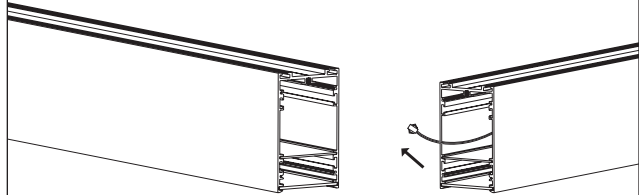

STEP 3

Align the two pieces together and then clip the Back Connector Plate into the channels situated on the back of the pieces.

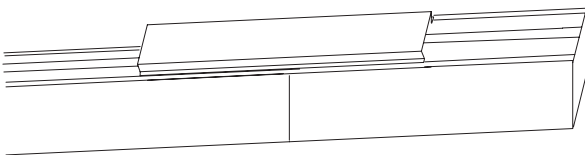

STEP 4

Clip the Side Connector Plates onto each side of the joint.

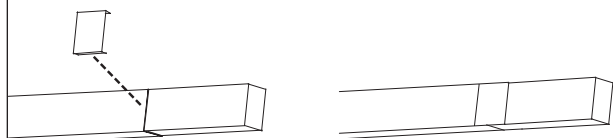

Estrella Simplicity

CONNECTING LINEAR PIECES

PARTS CHECKLIST



**Side Connector
Plate X2**



**Back Connector
Plate X1**

STEP 1

Remove the end cap of the linear piece (on the opposite side from the exiting cable). Then Remove the end cap of the connecting shape piece.

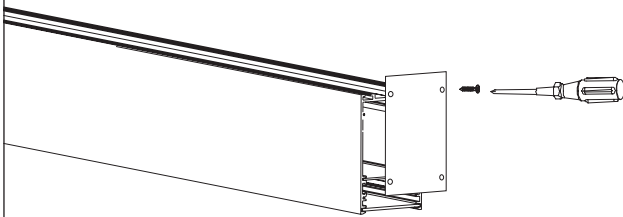

STEP 2

Align the two pieces together and then clip the Back Connector Plate into the channels situated on the back of the pieces.

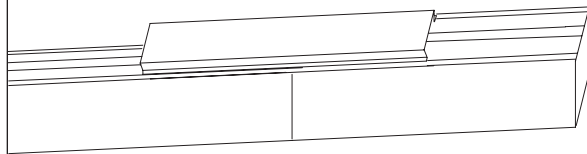

STEP 3

Clip the Side Connector Plates onto each side of the joint.

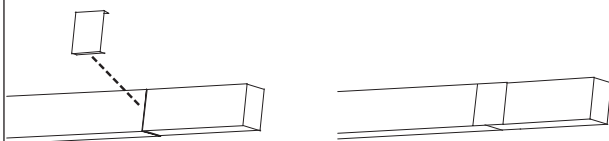

STEP 4

Connect the power cable from each linear piece into the mains supply.

